

1

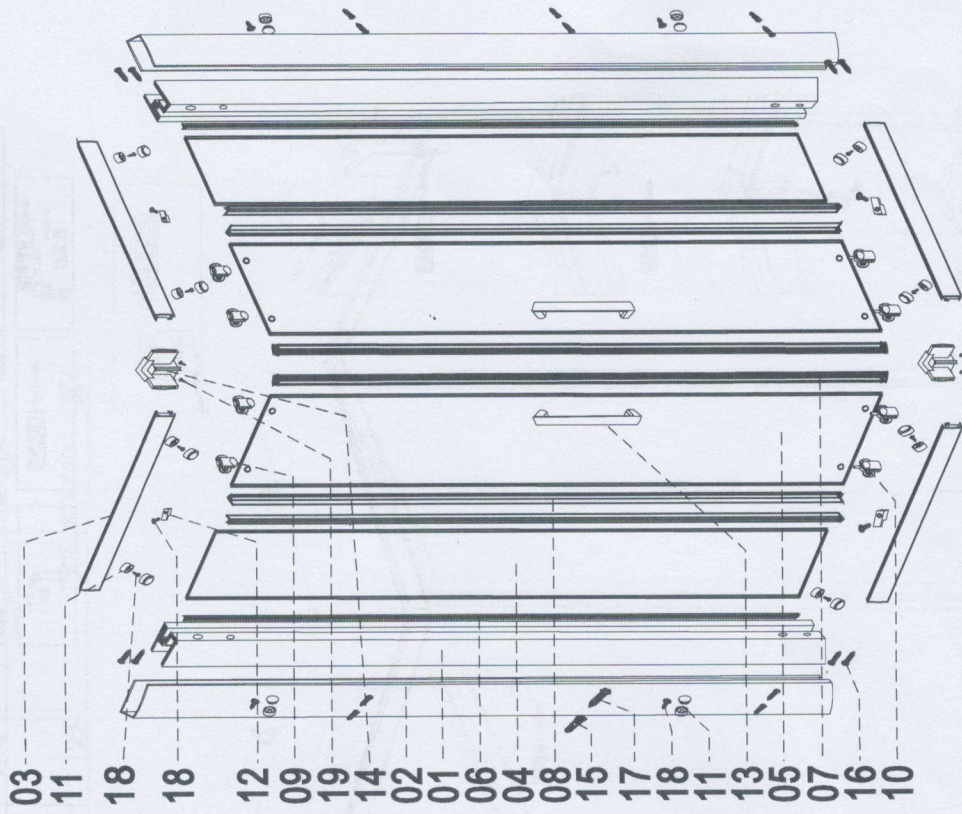

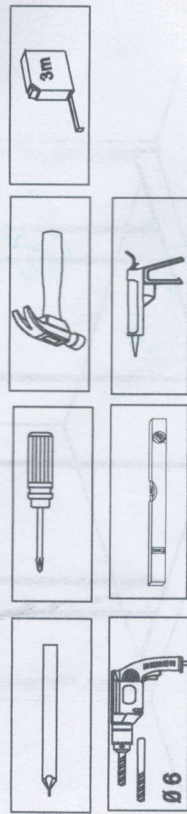

4

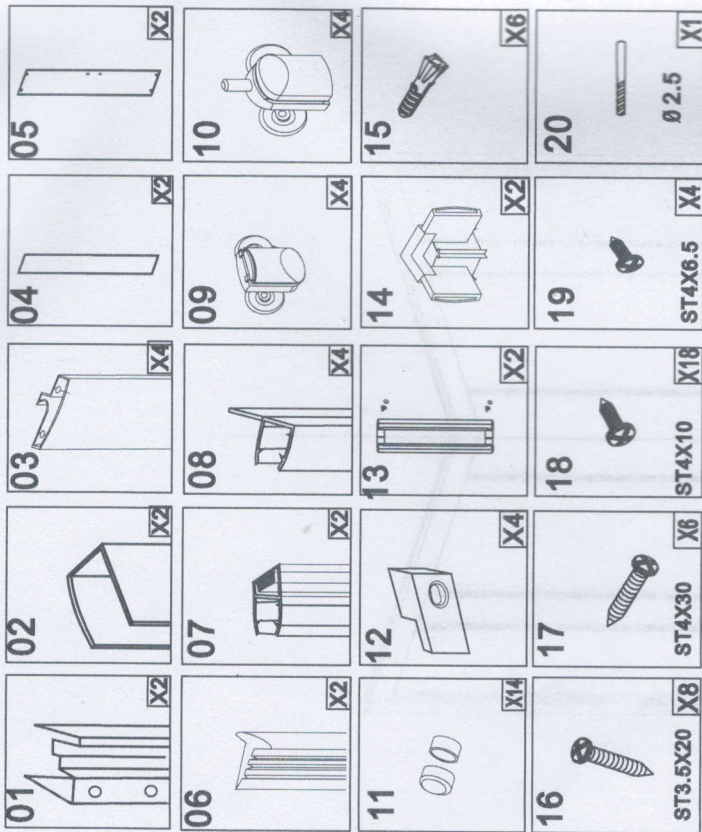
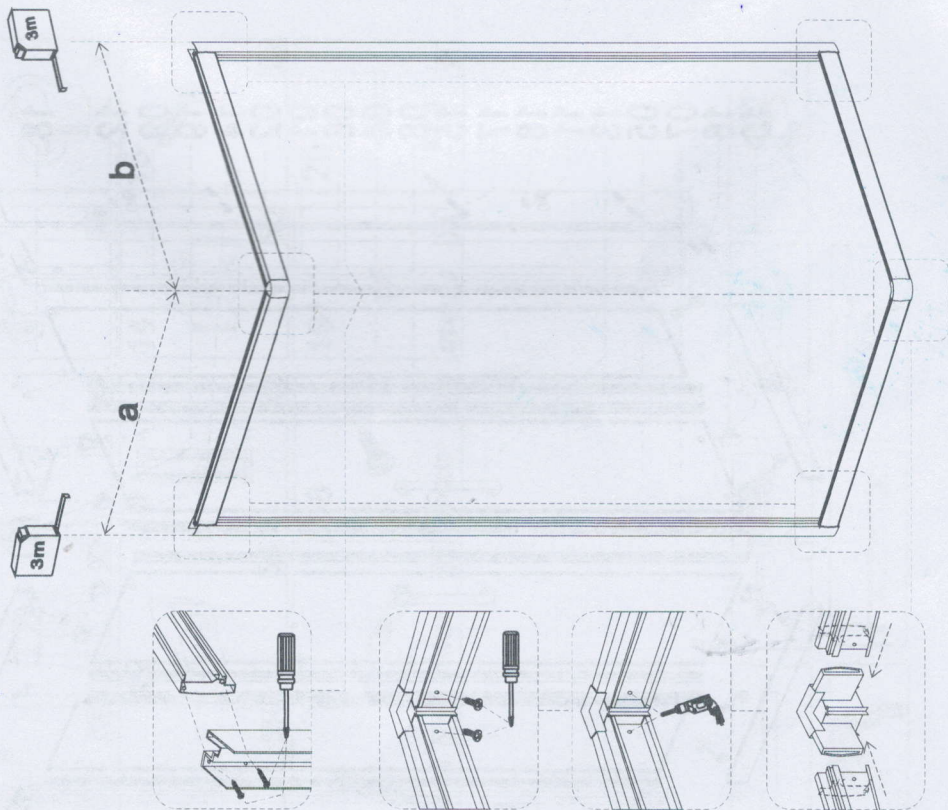
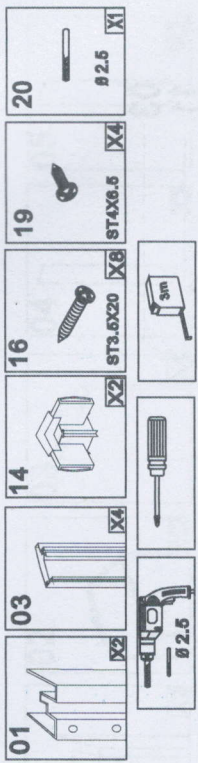
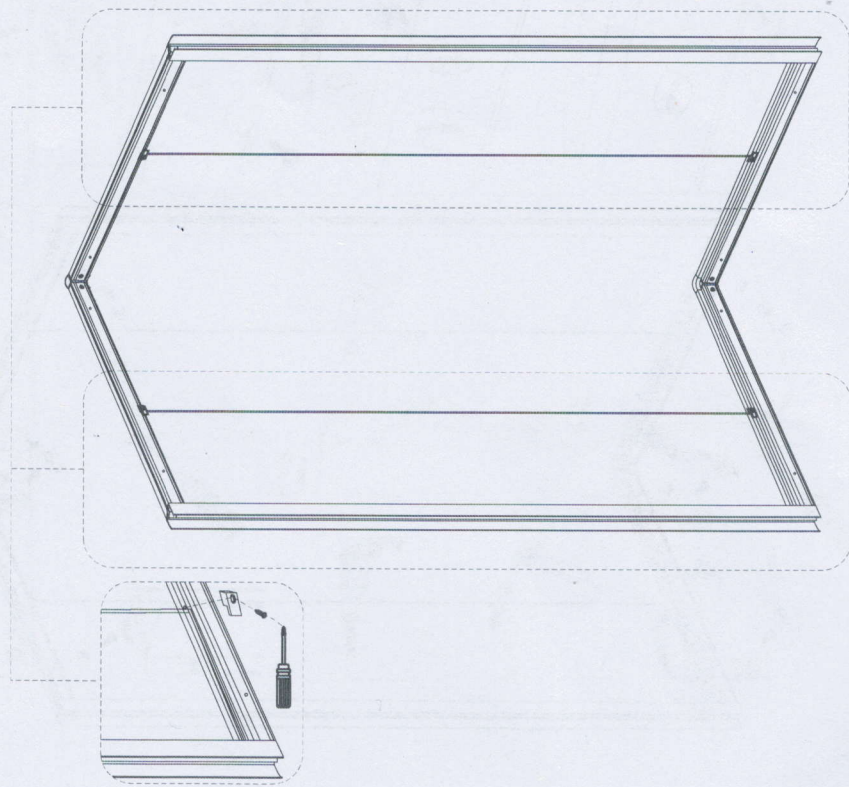
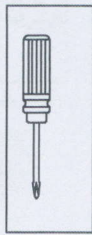
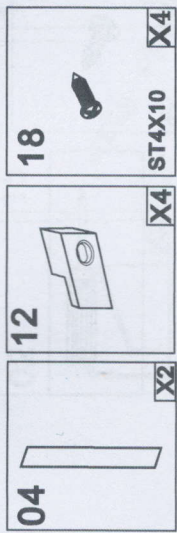

5



ST4X30

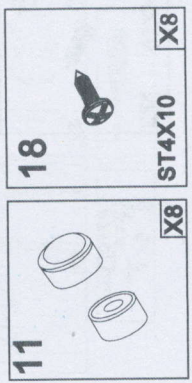
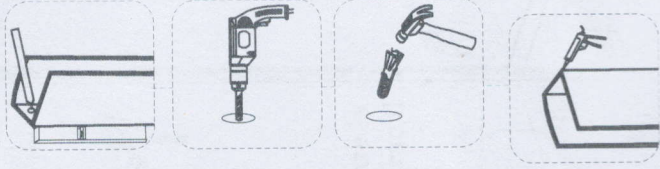
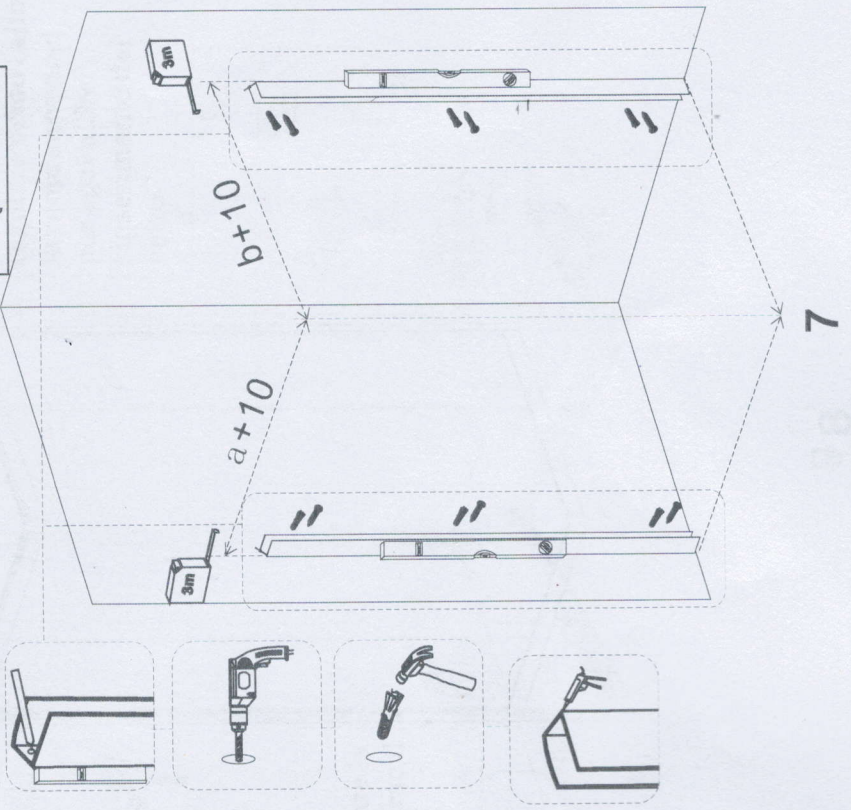
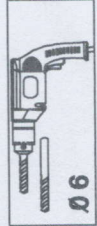
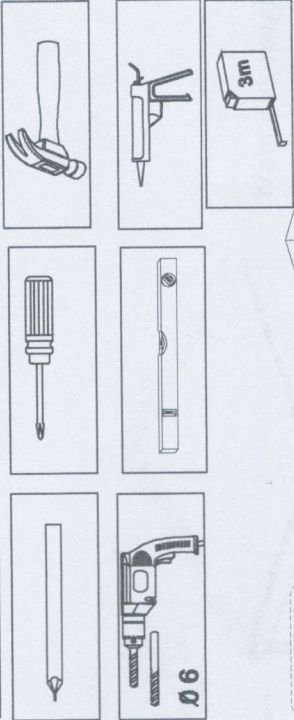

ST4X10

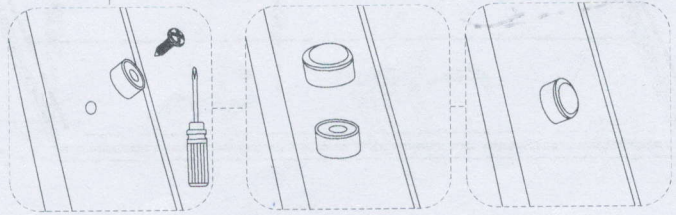
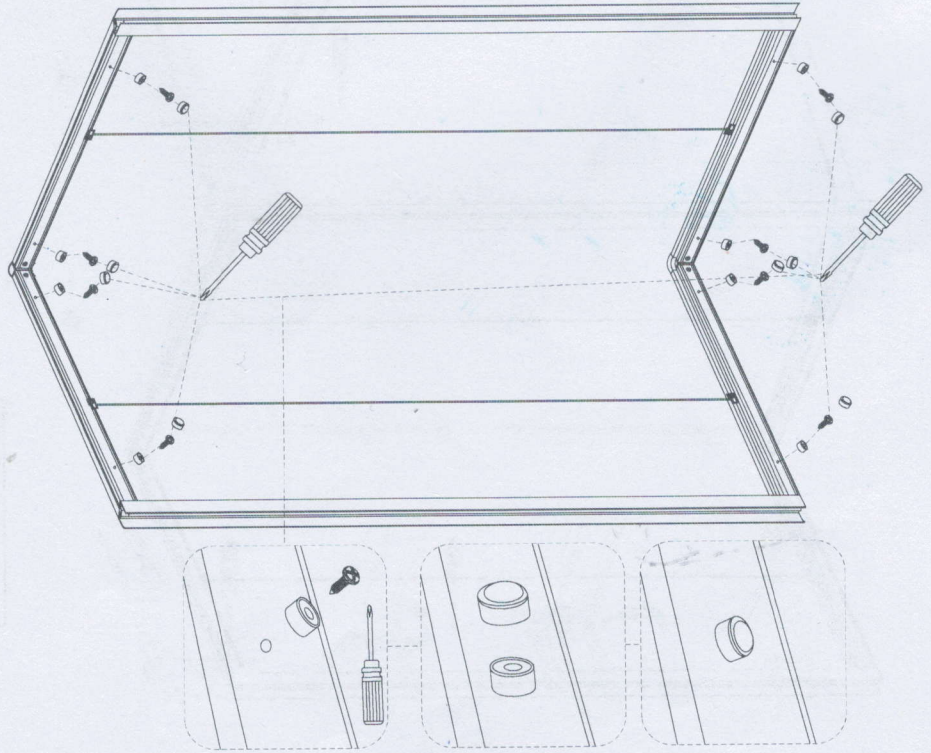

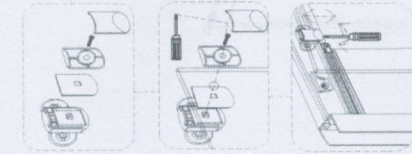
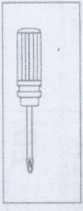
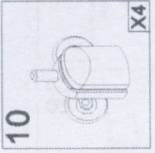
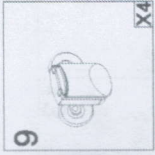
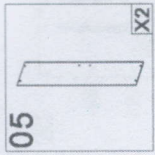
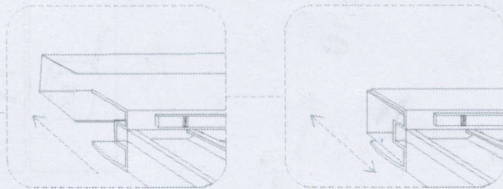
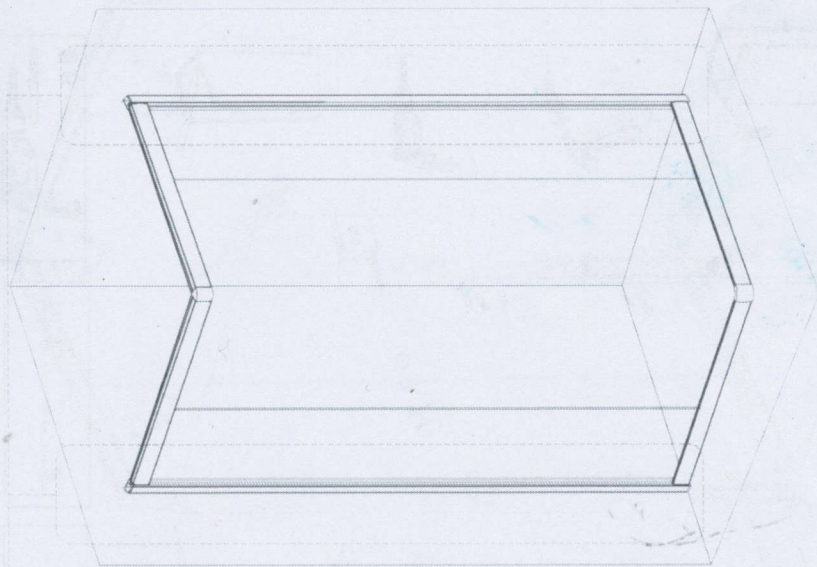
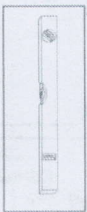

Nota:
Riregolare la
ruota verso il
basso.

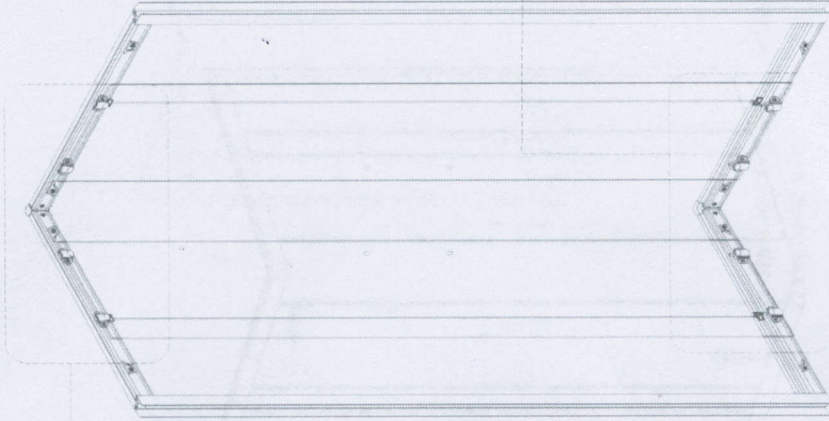

Nota: si consiglia di
regolare verso l'alto
le ruote superiori
per agevolare
l'inserimento del
vetro

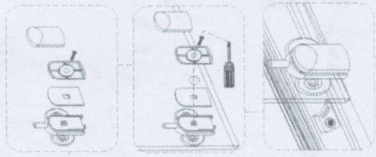

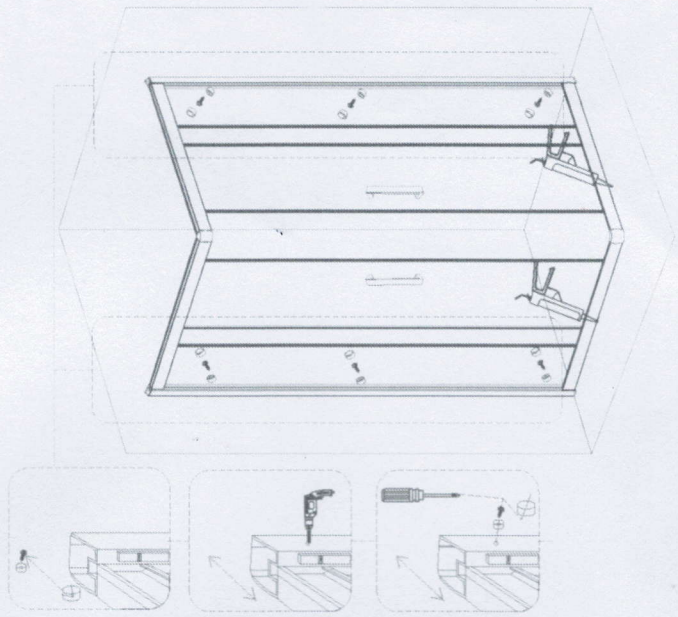
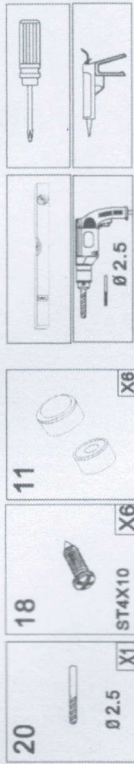

! Note: Dopo aver livellato i profili fissare le viti **!**

11

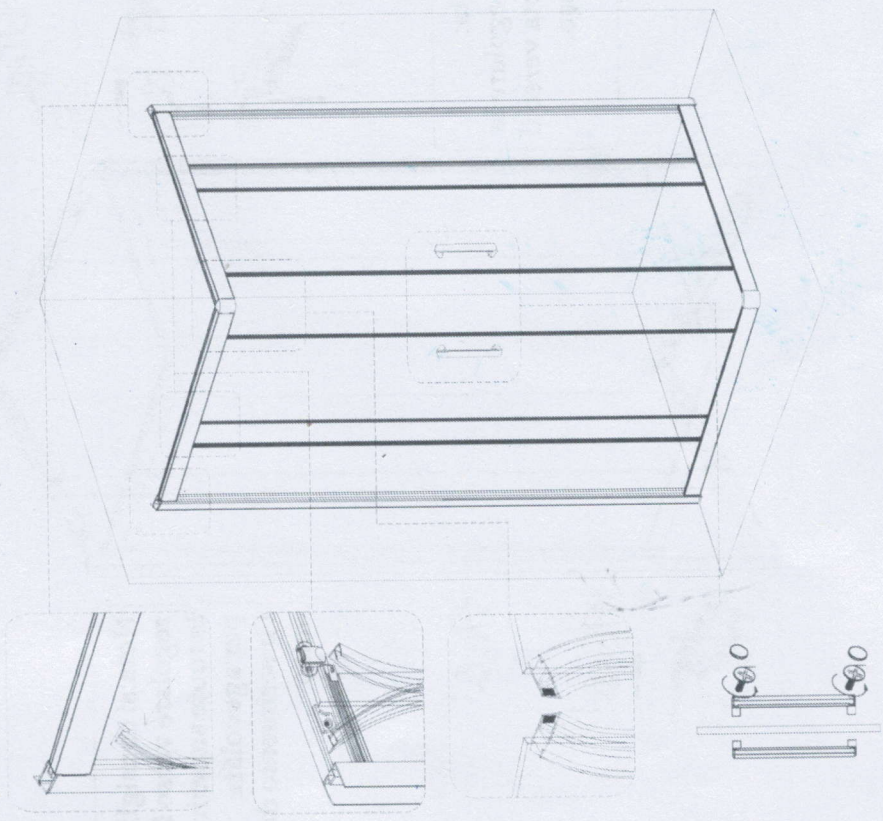
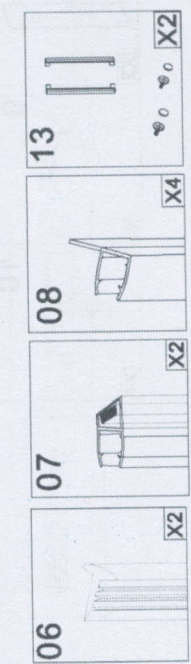

10